



Radiant Charbroiler



USCER- 24



USCER- 36



USCER- 48

Standard Features

- Durable stainless steel structure, corrosion-resistant and easy to clean
- Highly efficient stainless steel burner, standby pilots.
- Thick stainless steel radiant plates, for quick and even heating
- Independent manual controls to save the energy
- Adjustable multi-level top grates
- Adjustable stainless steel legs
- Unit ships Natural Gas with LP conversion kit, included

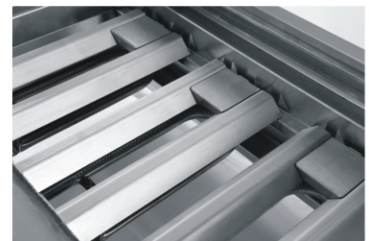

Plan View

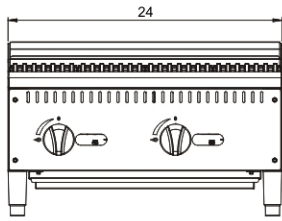

USCBR- 24

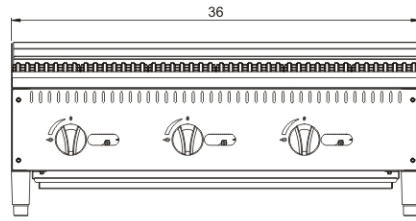

USCBR- 36

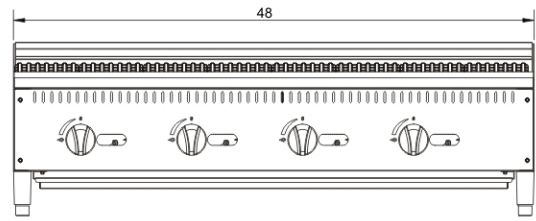

USCBR- 48

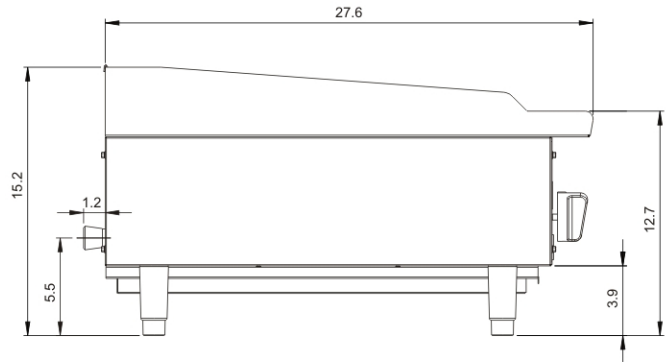
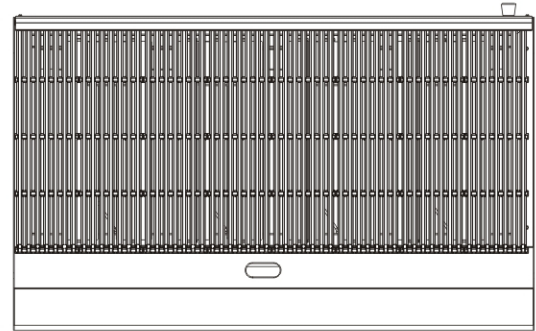
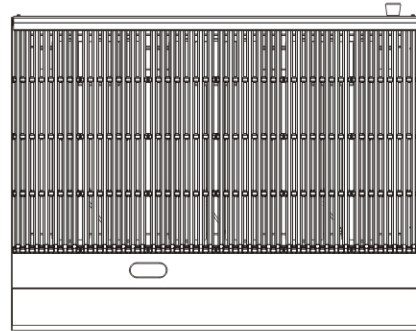
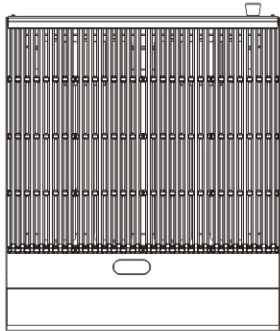

Conforms to ANSI
STD Z83.11b-2009(2011)
Certified to CSA
STD 1.8b-2009(2011)
Conforms to NSF/ANSI STD.4

Specifications

Model	Burners and Control Method	Gas type	Intake-tube pressure (in.W.C.)	Per BTU B.T.U./h	Total BTU B.T.U./h	Nozzle No.	ATRB Net weight(LBS) radiant
USCBR- 24	2 Burners Independent Manual control	NG	4	35,000	70,000	#36	113.5
		LP	10	35,000	70,000	#50	
USCBR- 36	3 Burners Independent Manual control	NG	4	35,000	105,000	#36	160.9
		LP	10	35,000	105,000	#50	
USCBR- 48	4 Burners Independent Manual control	NG	4	35,000	140,000	#36	205
		LP	10	35,000	140,000	#50	